

CLEAN **FORCE**®

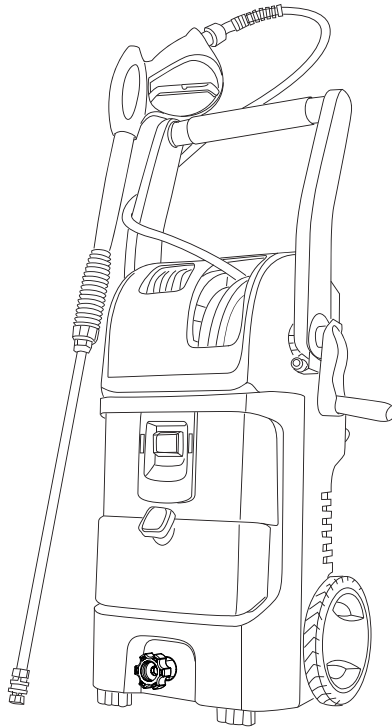

CF1800HD

Electric High Pressure Washer

Instruction Manual

Before operating this unit, please read this manual thoroughly and retain it for future reference.

**DO NOT RETURN PRODUCT TO PLACE OF PURCHASE.
IF YOU HAVE ANY QUESTIONS, CALL OUR TOLL FREE HOTLINE:**

1-866-902-9690

8:00 am to 5:00 pm, C.S.T., Monday - Friday

www.ForceToolsUSA.com

TABLE OF CONTENT

Important safety instructions.....	1
Safety features.....	4
Parts and diagram list.....	5
Assembly and operation instructions.....	6
Machine assembly.....	6
Operation instruction.....	8
Shut down and storage.....	13
Cleaning and maintenance.....	14
Troubleshooting.....	15
Technical data.....	19
Warranty.....	20

IMPORTANT SAFETY INSTRUCTIONS

**Please read all of the safety precautions before operating this machine every time.
Please pay particular attention to all sections with following symbols.**

⚠ WARNING ⚠

could cause injury or death if not followed

⚠ CAUTION ⚠

could damage machine if not followed

⚠ WARNING ⚠

When using this product, basic precautions should always be followed, including:

- 1 Read all instructions before using the product.
- 2 To reduce the risk of injury, do not operate the machine near children.
- 3 Learn how to stop this product and release pressure quickly. Be thoroughly familiar with the controls.
- 4 Stay alert - watch what you are doing.
- 5 Do not operate this product when fatigued or under the influence of alcohol or drugs.
- 6 Keep operating area clear of all people and pets.
- 7 Do not stand on unstable surfaces. Do not overreach or stand on unstable support. Keep good footing and balance at all times.
- 8 Follow the maintenance instructions specified in the manual.
- 9 This product is provided with a Ground Fault Circuit Interrupter (GFCI) built into the power cord. If replacement of the plug or cord is needed, use only identical replacement parts.
- 10 This product or its power cord contains lead, a chemical known to cause cancer, birth defects or other reproductive harm. Wash hands after handling.

IMPORTANT SAFETY INSTRUCTIONS

⚠ WARNING ⚠

Risk of injury

Injection Hazard

- Equipment can cause serious injury if the spray penetrates the skin.
- Do not point the gun at anyone or any part of the body. In case of penetration, seek medical aid immediately.

⚠ WARNING ⚠

Risk of injury

Do Not direct discharge stream at self or other persons.

- High-pressure jet can be dangerous if misused.
- The jet must not be directed at persons, animals, electrical devices, or the unit itself.

⚠ WARNING ⚠

Risk of Explosion

- Do not spray flammable liquids.
- Do not use acids and solvents in this product.
- These products can cause physical injuries to the operator and irreversible damage to the machine.

⚠ WARNING ⚠

Risk of Electric Shock

- Inspect cord before using - do not use if cord is damaged.
- Keep all connections dry and off the ground.
- Do not touch plug with wet hands.

⚠ CAUTION ⚠

Gun Kicks Back

- Hold with both hands.
- The trigger gun safety lock prevents the trigger from being engaged accidentally.
- The safety feature DOES NOT lock trigger in the ON position.

GENERAL SAFETY RULES

1. Never operate the machine without all components properly connected to the machine (handle, gun/wand assembly, nozzle, etc.).
2. Never operate pressure washer with broken or missing parts. Check equipment regularly and repair or replace worn or damaged parts immediately.
3. Never put hand or fingers over the nozzle or spray tip while operating the unit.
4. Never spray flammable liquids or use pressure washer in areas containing combustible dust, liquids or vapors. An electric spark could cause an explosion.
5. Never leave the wand unattended while the machine is running or switched on.
6. Never disconnect the high pressure discharge hose from the machine while the system is pressurized. To depressurize machine, turn power and water supply off, then depress gun trigger 2-3 times.
7. Never cover the pressure washer during operation to allow free air cooling.

IMPORTANT SAFETY INSTRUCTIONS

- Always wear safety glasses or goggles when operating or performing maintenance.
- Always move switch on unit to "OFF" position before connecting or disconnecting cord to electrical outlets.
- Always turn water supply "on" before turning pressure washer "on" unless draining for storage. Running pump dry causes serious damage.
- Always hold gun and wand firmly when starting and operating the machine.
- Always follow detergent manufacturer's label recommendations for proper use of detergents. Always protect eyes, skin and respiratory system from detergent if used.
- Always lock the trigger of spray gun in the safety position when not in use.
- Do not use pressure that exceeds the operating pressure of any of the parts (hoses, fittings, etc.) in the pressurized system. Never use with any other manufacturer's accessories or components.
- Do not spray electrical apparatus and wiring or the machine itself.
- Do not operate the pressure washer with the inlet water filter removed. Keep filter clear of debris and sediment.
- Discharge residual pressure by depressing the trigger until no more water comes out of the nozzle.
- Keep clear of nozzle. Never direct high pressure spray at any person, animal or self.
- To minimize the amount of water getting into the pressure washer, the unit should be placed as far as possible from the cleaning site during operation.

GROUND FAULT CIRCUIT INTERRUPTER PROTECTION

This pressure washer is provided with a Ground Fault Circuit Interrupter (GFCI) built into the power supply cord. This device provides additional protection from the risk of electrical shock. Should replacement of the plug or cord become necessary, use only identical replacement parts that include GFCI protection. See Page 4 for testing procedure.

⚠ WARNING ⚠

Connect directly to outlet. Do not use machine with extension cord. The use of an extension cord will override the GFCI built into the plug of the power supply cord resulting in the risk of electrical shock.

DOUBLE-INSULATION INSTRUCTION



In a double-insulation product, two systems of insulation are provided instead of grounding. No grounding is provided on a double-insulated product, nor should a means for grounding be added to the product.

Servicing a double-insulated product requires extreme care and knowledge of the system, and should be done only by qualified service personnel.

Replacement parts of a double-insulated product must be identical to the parts they replace. A double-insulated product is marked with the words "**DOUBLE-INSULATION**" or "**DOUBLE-INSULATED**". The symbol "□" may also be marked on the product.

SAVE THESE INSTRUCTIONS

SAFETY FEATURES

Total stop system (TSS)

The pressure washer is equipped with a total stop system (TSS) that will sense when the trigger on the gun is depressed or released. It will open the power circuit to the motor, and cause the pressure washer motor to stop. The motor will start again when the trigger is depressed.

⚠ WARNING ⚠

The pressure washer is also equipped with a main power "ON/OFF" switch located on the unit. It should always be moved to the "OFF" position when the pressure washer is not being used to prevent possible injury or damage.

Ground Fault Circuit Interrupter Protection

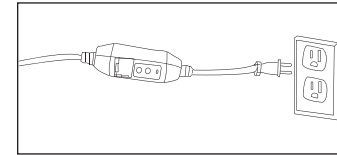

This device provides additional protection from the risk of electrical shock. Plug the Ground Fault Circuit Interrupter (GFCI) into a power outlet. Indicator should turn red. **TEST BEFORE EACH USE.** Press the "TEST" button. Red indicator should disappear. Press "RESET" button again for use. Do not use if above test fails.

Extension Cords

If possible, do not use extension cords with this product. However, if you must use one, observe all of the warnings and instructions listed below:

⚠ WARNING ⚠

Extension cords are not recommended unless they are plugged into a ground fault circuit-interrupter (GFCI) found in circuit boxes or protected receptacles.

Use a sufficient gauge:

Maximum cable length: 50' (15.2 m). Only use 12 or 14 AWG rated extension cords.

- Use only extension cords that are intended for outdoor use. These extension cords are identified by a marking that reads "Acceptable for use with outdoor appliances; store indoors while not in use."
- Use only extension cords having an electrical rating not less than the rating of the product.
- Do not use damaged extension cords. Examine extension cord before using and replace if damaged. Do not abuse extension cord and do not yank on any cord to disconnect.
- Keep cord away from heat and sharp edges.
- Always disconnect the extension cord from the receptacle before disconnecting the product from the extension cord.
- To reduce the risk of electric shock, keep all connections dry and off the ground. Do not touch plug with wet hands.

SAFETY FEATURES

⚠ CAUTION ⚠

This machine has been designed for use with detergents that are specifically approved for pressure washer use. The use of other cleaning detergents may affect the operation of the machine and void the warranty.

PARTS AND DIAGRAM LIST

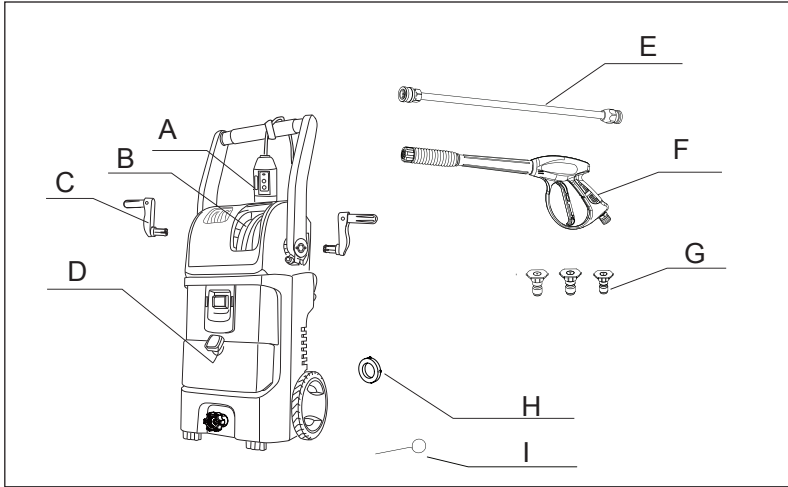

Item No.	Quantity	Part Name
A	1	Ground Fault Circuit Interrupter (GFCI)
B	1	High-pressure hose
C	2	Hand crank
D	1	Detergent tank
E	1	Quick-connect wand
F	1	Gun wand
G	3	Spray tips
*H	1	Water filter
I	1	Needle (for nozzle cleaning)

* Water filter come pre-attached on the water inlet, located on the front of the pressure washer.

ASSEMBLY AND OPERATION INSTRUCTIONS

Surface Preparation

Before starting any cleaning task, it is important to inspect the area for objects that could create a hazard. Remove any objects from the work area that could be tripped over, such as toys or outdoor furniture. Ensure that all doors and windows are closed tightly.

Water Supply (Cold Water Only)

Only draw water through the unit. For use with cold water supply only. Water hose must be at least a 1/2" (13 mm) in diameter. Flow rate of water supply must not fall below 2 GPM (gallons per minute) [9.1 LPM (liters per minute)]. Flow rate can be determined by running the water for one minute into an empty 5-gallon (19 L) container. The water supply temperature must not exceed 104°F (40°C).

⚠ CAUTION ⚠

- Never use the pressure washer to draw in water contaminated with solvents (e.g. paint thinners, gasoline, oil, etc.).
- Dirt in the water inlet will damage the unit. To avoid this risk, we recommend checking the water filter (located inside the water inlet. To clean it out, see Maintenance section).
- Always prevent debris from being drawn into the unit by using a clean water source and an additional accessory water filter if required.
- To prolong the life of the unit, rest the unit for 5 minutes after every 30 minutes of use.

MACHINE ASSEMBLY

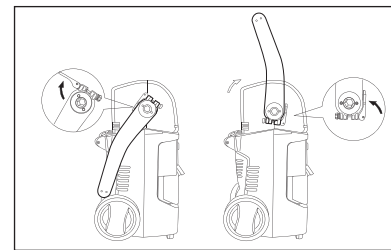

Raise handle to upright position and fix the position by cam – lock.

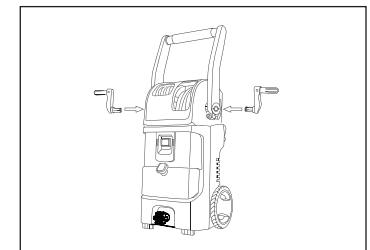

Attach hand cranks onto the hose reel and cord reel on both sides.

ASSEMBLY AND OPERATION INSTRUCTIONS

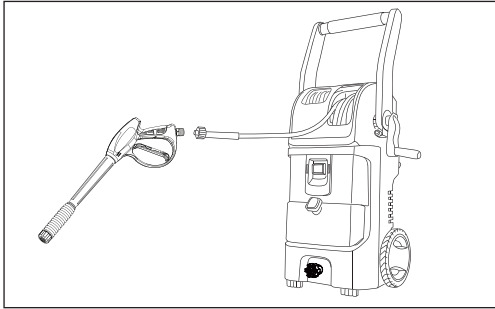

Attach high pressure hose from hose reel to the gun wand, hand tighten until two parts are locked.

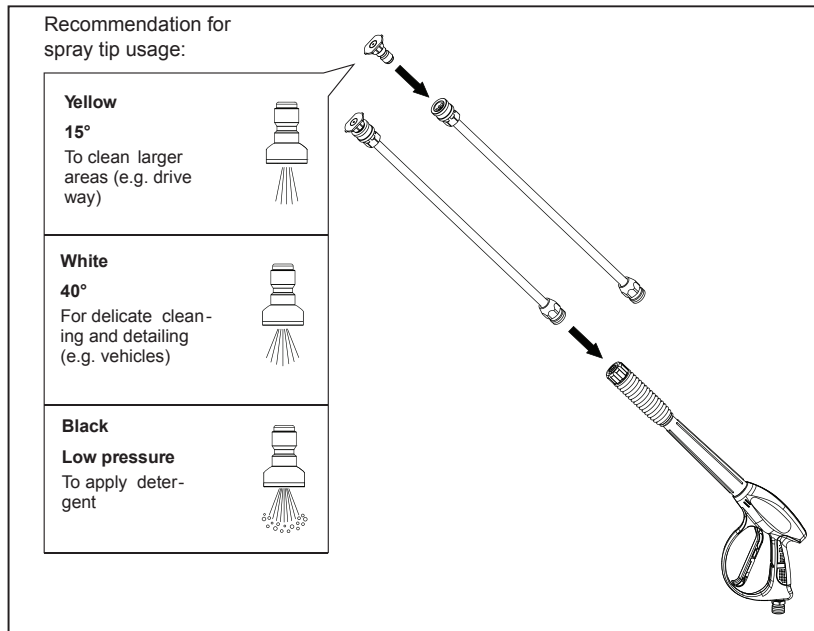

Attach desired color coded spray tip to quick - connect wand by pushing to ensure it is clicked in securely. Insert quick - connect wand into the gun wand, hand tighten until two parts are locked.

ASSEMBLY AND OPERATION INSTRUCTIONS

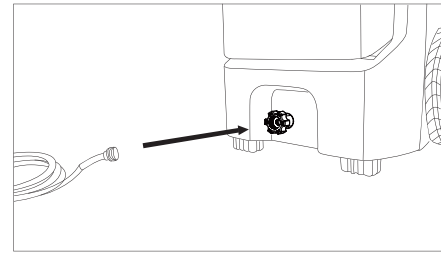

Attach the garden hose to the water inlet (hand tighten only).

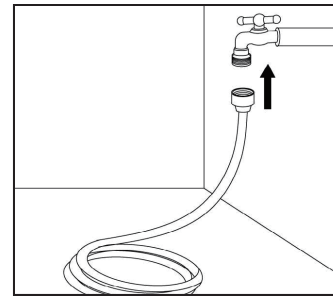

Attach garden hose to cold water source and turn water on full. The water temperature must not exceed 40°C (104°F) and the supply pressure must be between 40 to 80 PSI.

⚠ CAUTION ⚠

The pressure washer must only be used with clean water. Use of unfiltered water or corrosive chemicals will damage the pressure washer. This pressure washer is not intended to pump hot water. Never connect it to a hot water supply as it will significantly reduce the life of the pump.

OPERATION INSTRUCTIONS

⚠ WARNING ⚠

Risk of injury, Do Not Direct discharge stream at self or other persons.

⚠ WARNING ⚠

Before cleaning any surface, an inconspicuous area should be cleaned to test spray pattern and distance for maximum cleaning results.

ASSEMBLY AND OPERATION INSTRUCTIONS

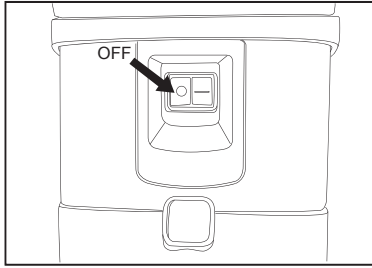

Make sure the ON/OFF switch is on the OFF position before plugging in the unit, press the switch button with mark "O" to ensure it is off.

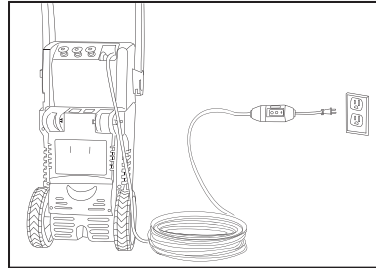

Completely unwind power cord by pulling and plug the Ground Fault Circuit Interrupter (GFCI) into a power outlet. Indicator should turn red. **TEST BEFORE EACH USE.** Press the "TEST" button. Red indicator should disappear. Press "RESET" button again for use. Do not use if above test fails.

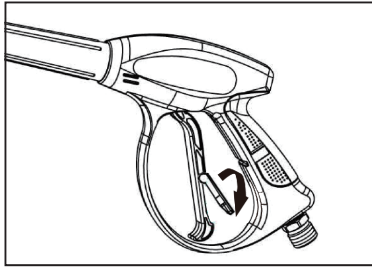

Ensure the gun safety latch is released by pushing it down and engage the trigger for a few seconds to discharge the residual pressure in the high pressure hose.

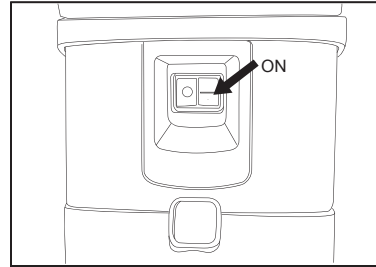

Turn ON the pressure washer by pressing the button with mark "—". The unit will run for a few seconds to build up pressure, then will stop on the function of total stop system (TSS).

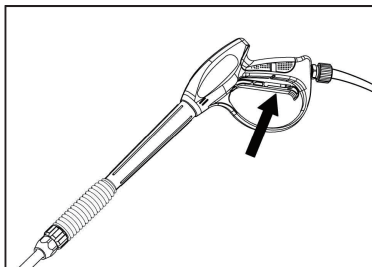

Depress the gun trigger until there is a steady stream of water. Change the spray tip as per the recommendation above if necessary. Before changing spray tip, switch the machine off, depress trigger to release pressure and activate gun safety latch.

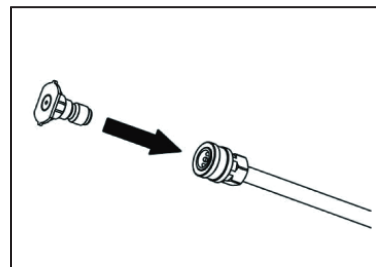

ASSEMBLY AND OPERATION INSTRUCTIONS

⚠ CAUTION ⚠

Make sure spray tip and wand is well locked. Do not move the spray tip while trigger is depressed.

⚠ CAUTION ⚠

If painted surfaces are peeling or chipping, use extreme caution as pressure washer may remove the loose paint from the surface. For most cleaning applications, a twenty degree (20°) spray angle be recommended to avoid damage to the surface being sprayed. The pressure of spray on the surface will increase when you move the wand closer to the surface.

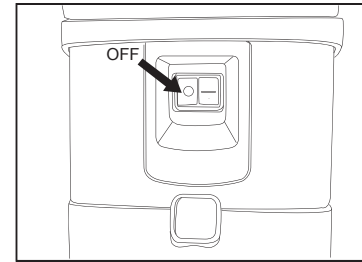

CLEANING DETERGENTS DISPENSER

Only use cleaning detergents recommended for pressure washers. Always follow detergent manufacturer's label recommendations for proper use of detergents or soap. Always protect eyes, skin and respiratory system from detergent if used.

Turn off the pressure washer by pressing the switch button with mark "O", activate the safety latch for a break. For storage, drain machine after use by removing water connection, turning ON the machine for a few seconds and depressing gun trigger to release remaining water in the pump. Turn OFF immediately.

⚠ CAUTION ⚠

Working with detergent ensures a quick soaking of the dirt, and allows the high-pressure water to penetrate and remove the dirt more effectively. Always spray detergent on a dry surface, do not pre-soak area. Wetting the surface first dilutes the detergent and reduces its cleaning ability.

To apply detergents you must be operating at low pressure. This provides a gentle application of detergent, with the pressure equivalent to the lowest garden hose. The high-pressure setting is used for cleaning; you cannot apply detergents when working at high pressure. Always test detergent in an inconspicuous area before use.

ASSEMBLY AND OPERATION INSTRUCTIONS

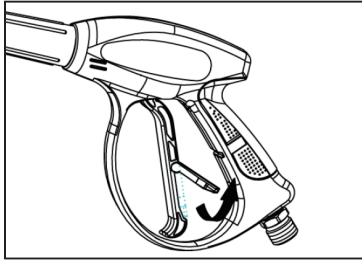

1 Engage gun safety lock.

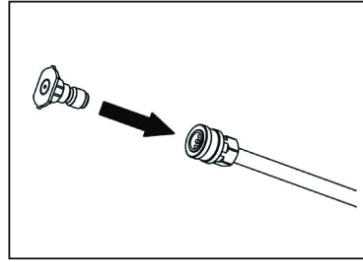

2 Attach the low-pressure spray tip (black) for soap or detergent application. Detergent application will only work with low pressure spray tip.

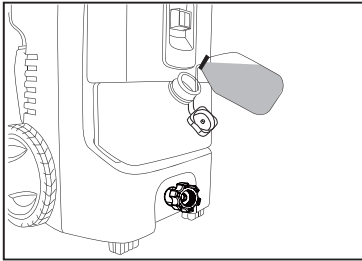

3 Lift up to remove the cap of detergent tank, fill tank with detergent or soap and replace the cap. Apply detergent as instructed by the detergent manufacturer.

- 4 Turn on the pressure washer. Depress trigger to operate unit. The liquid detergent will automatically mix with water, and be discharged through the nozzle. Apply detergent to a DRY work surface, from bottom to top.
- 5 Allow detergent to remain on the surface for a short time before rinsing. Do not allow detergent to dry on surface.
- 6 Rinse with clean water under high pressure. On a vertical surface, rinse from the bottom up, then rinse from the top down to avoid streaking. Hold nozzle 6-8" (15-20 cm) from the cleaning surface, at a 45° angle.
- 7 When you have finished using the detergent dispensing system, fill detergent tank with clean water to rinse the system clean. Depress the gun trigger for one minute at low pressure so that all detergents remaining in system are thoroughly flushed out. Remove detergent tank to empty the remaining water, and rinse it until it is thoroughly cleaned.

ASSEMBLY AND OPERATION INSTRUCTIONS

⚠ CAUTION ⚠

Fail to follow detergent clean procedure will cause the dispensing system to become clogged
Damage may occur to painted surface if chemical is allowed to dry on surface.
Wash and rinse a small section at a time. Avoid working on hot surfaces or in direct sunlight.

Never use:

- Bleach, chlorine products and other corrosive chemicals
- Liquids containing solvents (i.e., paint thinners, gasoline, oils)
- Tri-sodium phosphate products
- Ammonia products
- Acid-based products

These chemicals will harm the unit and will damage the surface being cleaned.

SHUT DOWN AND STORAGE

- 1 (If you are not using detergent, go directly to Step 2.) When you have finished using the detergent dispensing system, fill detergent tank with clean water to rinse the system clean. Depress the gun trigger for one minute at low pressure so that all detergents remaining in system are thoroughly flushed out. Remove detergent tank to empty the remaining water, and rinse it until it is thoroughly cleaned.
- 2 Turn off water supply and disconnect the garden hose from the faucet and the water inlet on the unit.
- 3 Depress the gun trigger for a few seconds to release any remaining water until water spray stops, turn off unit immediately.
- 4 Unplug the Ground Fault Circuit Interrupter (GFCI) from the power outlet and wrap power cord into the cable reel by rotating the reel with hand crank.
- 5 For storage, disconnect the high pressure hose from the gun wand and wrap hose into the hose reel by rotating the reel with hand crank.
- 6 Engage gun safety latch and disconnect the quick – connect wand from gun wand, disassembly and replace the spray tip to tip holder on the unit, insert the wand into the wand holder, turn back the hand to the down position.
- 7 Store the machine and accessories in a room that does not reach freezing temperatures. Do not store near furnace or other sources of heat as it may dry out the pump seals.

⚠ WARNING ⚠

Turn off water supply and depress trigger to depressurize the unit. Failure to do so could result in personal injury due to discharge of high-pressure water.

Optimum Winterizing Procedure

Winterizing your pressure washer will help protect and prolong its life. We strongly recommend you follow the below steps using pump saver. This will keep the internal parts lubricated, protected from rust, and prevents the pump from freezing.

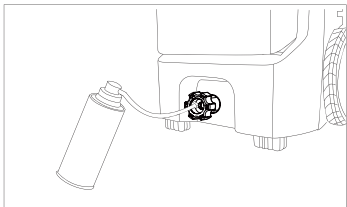

1. Connect Pressure Washer Pump Saver hose onto the water inlet.
2. Depress button on top of pump saver container.
3. Continue until fluid exits the pressure hose for 15 seconds.
4. Remove the hose from pump inlet (water inlet).

CLEANING AND MAINTENANCE

Water Filter Screen

The pressure washer is equipped with a water inlet filter screen to protect the pump. If the screen is not kept clean, the flow of water to the pressure washer will be restricted and the pump may be damaged.

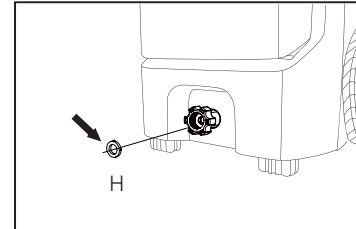

1. To clean inner water screen, remove the inlet adaptor and remove the filter screen from the pump inlet.
2. Rinse screen until it is free of debris and blockage.
3. Replace screen immediately to prevent any foreign matter from entering the pump.

Main body cleaning

Use only mild soap and damp cloth to clean the main body.

⚠ WARNING ⚠

Never use the unit to clean itself

Connections

Connections on pressure washer hoses, gun and spray wand should be cleaned regularly and lubricated with non-water soluble grease.

Spray Tips Only

Clogging of the spray tips causes the pump pressure to be too high and cleaning is immediately required. Clean the spray tips by carefully inserting a needle provided, or a thin and sharp instrument (i.e. paperclip) into the tip to remove any dirt deposited.

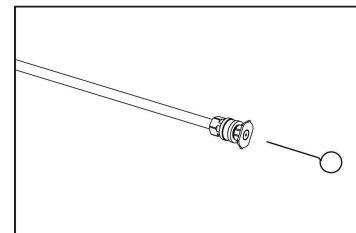

⚠ WARNING ⚠

To assure product safety and reliability, repairs should be performed by authorized service centers or other qualified service personnel, always use identical replacement parts.

TROUBLE SHOOTING

Disconnect the machine from the power source before making any repairs.

Symptom	Cause	Solution
Motor will not start.	On/Off switch is in the "OFF" (O) position.	Turn switch to the "ON" (—) position.
	GFCI is not plugged in.	Plug in GFCI.
	Extension cord is too long. Extension cord is not proper gauge. Extension cord is damaged.	Replace extension cord with either a 25' (7.6 m) 14/3 gauge cord or a 50' (15 m) 14/3 gauge cord.
	Electrical outlet does not supply adequate power.	Try a different outlet.
Unit does not reach high pressure.	Tripped pressure washer thermal protector.	Allow to cool, and restart unit.
	Diameter of garden hose is too small.	Replace with a 1" (25 mm) or 5/8" (16 mm) garden hose.
	Water supply is restricted.	Check garden hose for kinks, leaks and blockage.
	Not enough water supply.	Open water source fully.
	Water inlet filter is clogged.	Remove filter and rinse in warm water.
	Power nozzle is in low-pressure position.	Replace with desired high-pressure tip.

TROUBLE SHOOTING

Symptom	Cause	Solution
	Pump is sucking air.	Check that hoses and fittings are airtight. Turn "OFF" machine, and purge pump by squeezing trigger gun until a steady flow of water emerges through the nozzle.
Output pressure varies high and low.	Not enough inlet water supply.	Turn water on fully. Check garden hose for kinks, leaks or blockage.
	Pump is sucking air.	Check that hoses and fittings are airtight. Turn "OFF" machine, and purge pump by squeezing trigger gun until a steady flow of water emerges through the nozzle.
	Water inlet filter is clogged.	Remove filter and rinse with warm water.
Output pressure varies high and low. (continued)	Discharge nozzle is obstructed.	Blow out or remove debris with a fine needle.
	Calcified gun, hose or power nozzle.	Run distilled vinegar through detergent tank.
Detergent is not working.	Detergent container is empty.	Add more detergent.
	Detergent bottle or suction tube not properly connected.	Check connections.
	Detergent is too thick.	Dilute detergent.

TROUBLE SHOOTING

Symptom	Cause	Solution
	Filter on detergent suction tube is clogged.	Run warm water through filter to remove build-up.
	Damaged or clogged detergent suction tube.	Remove obstruction or replace detergent suction tube.
	Nozzle is in high-pressure position.	Use low pressure (black) tip.
	Discharge nozzle is obstructed.	Blow out or remove debris with a fine needle.
Garden hose connection leaks.	Loose fittings.	Tighten fittings.
	Missing/worn rubber washer.	Insert new washer.
Spray wand, extension, or nozzle leaks.	Spray nozzle not properly attached.	Ensure quick-connect wand is attached securely. Ensure spray tip is clicked in securely.
	Broken o-ring or plastic insert.	Call the Toll-Free Hotline.
Pump is noisy.	Pump is sucking air.	Check that hoses and fittings are airtight. Turn off machine and purge pump by squeezing trigger gun until a steady flow of water emerges through the nozzle.
	Water filter is clogged.	Remove water filter and rinse in warm water.
Water leaks from pump (up to 10 drops per minute is permissible).	Loose fittings.	Check that all fittings are tight.

TROUBLE SHOOTING

Symptom	Cause	Solution
	Water seals are damaged or worn.	Call the Toll-Free Hotline.
Oil is dripping.	Oil seals are damaged or worn.	Call the Toll-Free Hotline.
Motor buzzes but fails to run.	Supply voltage below minimum.	Verify that only the pressure washer is running on this circuit.
	System has residual pressure.	Turn unit "OFF", squeeze trigger on spray wand to release pressure, then turn unit "ON".
	Voltage loss due to extension cord.	Unplug any extension cords attached and plug the unit directly into the outlet.
	Pressure washer not used for long periods.	Call the Toll-Free Hotline.
No water.	Water supply is OFF.	Turn ON water supply.
	Kink in the garden hose.	Remove kink in garden hose.
	Residual friction among components. Unit might hum.	Disconnect water supply and power ON for 2 to 3 seconds, repeat couple times or until the motor starts.

IF YOU HAVE ANY QUESTIONS, CALL OUR TOLL FREE HOTLINE:

1-866-902-9690

8:00 am to 5:00 pm, C.S.T., Monday - Friday

www.ForceToolsUSA.com

TECHNICAL DATA

Power source requirement: 120 V / 60 Hz
Rated current: 13 A
Max. pressure: 1800 PSI
Rated working pressure: 1700 PSI
Max. flow rate: 1.5 GPM
Rated flow rate: 1.35 GPM
Electrical cord: 35'
High-pressure Hose: 23'
Inlet water: Cold tap water, max. 40°C
Detergent injection rate: 3~12%
Nozzle spray angle of tips (high pressure): 15°, 40°

WARRANTY

Product Warranty

Always keep your receipt as proof of purchase.

This product has a Parts Replacement, Product Exchange and/or Repair Warranty only. NO REFUNDS will be provided. Please see stores for Product Exchange details

Two-(2) year Warranty - Motor And Pump

This product is warranted to be free from defects in material and workmanship for two years from the date of its original purchase. If such a defect appears during the warranty period, upon presentation of proof of purchase, Altaquip will repair or replace the product (at its option). If deemed non-repairable, product will be exchanged. Shipping charges may apply.

Ninety-(90) day Warranty - Accessories

Spray gun, hose, wand, tips, and other accessories are warranted for ninety (90) days from the date of purchase.

This warranty does not cover accidental damage, unreasonable use, normal wear and tear, use of improper detergents, freezing, neglect, or non-compliance with Operating Instructions. Warranty does not cover loss of use, or other consequential damages arising from any of the above, nor does it cover repairs made or attempted by unauthorized persons.

Warranty is void if the equipment is used for commercial, rental or industrial purposes.

If you have more questions, call toll free: (866) 902-9690